



Micro Commercial Components

Micro Commercial Components
 20736 Marilla Street Chatsworth
 CA 91311
 Phone: (818) 701-4933
 Fax: (818) 701-4939

BAS21A/C/S

Features

- Power dissipation: 225mW ($T_{amb}=25^{\circ}C$)
- Forward current: 200mA
- Case Material: Molded Plastic. UL Flammability Classification Rating 94V-0 and MSL Rating 1

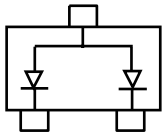

BAS21A

Marking: JS2

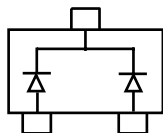

BAS21C

Marking: JS3

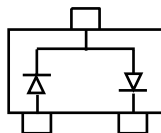

BAS21S

Marking: JS4

225mW 250Volt Switching Diode

SOT-23

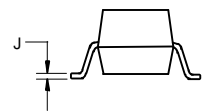
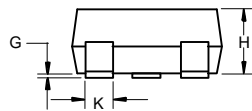
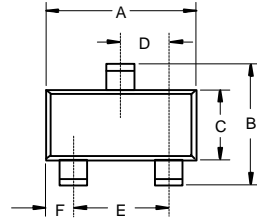

Maximum Ratings

- Operating Temperature: $-55^{\circ}C$ to $+150^{\circ}C$
- Storage Temperature: $-55^{\circ}C$ to $+150^{\circ}C$

Electrical Characteristics @ 25°C Unless Otherwise Specified

Reverse Breakdown Voltage	$V_{(BR)}$	250V	$I_R=100 \mu A$
Maximum Instantaneous Forward Voltage	V_F	1100mV	$I_{FM} = 100mA$; $T_J = 25^{\circ}C$
Maximum DC Reverse Current At Rated DC Blocking Voltage	I_R	1 μA	$V_R=200Volts$ $T_J = 25^{\circ}C$
Diode Capacitance	C_D	5pF	Measured at 1.0MHz, $V_R=0V$
Reverse Recovery Time	T_{rr}	50nS	

DIM	INCHES		MM		NOTE
	MIN	MAX	MIN	MAX	
A	.110	.120	2.80	3.04	
B	.083	.098	2.10	2.64	
C	.047	.055	1.20	1.40	
D	.035	.041	.89	1.03	
E	.070	.081	1.78	2.05	
F	.018	.024	.45	.60	
G	.0005	.0039	.013	.100	
H	.035	.044	.89	1.12	
J	.003	.007	.085	.180	
K	.015	.020	.37	.51	

Suggested Solder Pad Layout

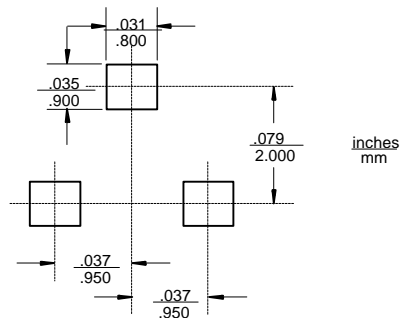



Micro Commercial Components

Ordering Information

Device	Packing
(Part Number)-TP	Tape&Reel;3Kpcs/Reel

IMPORTANT NOTICE

Micro Commercial Components Corp. reserves the right to make changes without further notice to any product herein to make corrections, modifications, enhancements, improvements, or other changes. *Micro Commercial Components Corp.* does not assume any liability arising out of the application or use of any product described herein; neither does it convey any license under its patent rights, nor the rights of others. The user of products in such applications shall assume all risks of such use and will agree to hold *Micro Commercial Components Corp.* and all the companies whose products are represented on our website, harmless against all damages.

APPLICATIONS DISCLAIMER

Products offer by *Micro Commercial Components Corp.* are not intended for use in Medical, Aerospace or Military Applications.